

RXR 130

ES

Montaje: Empotrado.
Fuente de luz: Módulos compactos LED SMD TRIDONIC.
 Temperatura de color 4000K. Disponible, 3000K.
Sistema óptico: Reflector aluminio brillante facetado.
Distribución luminosa: Directa. Estándar 24°. Disponible 16°, 38°.
Equipo eléctrico: Equipo de control electrónico TRIDONIC. PF>0,95.
 Disponible, regulable 1-10V o DALI y/o kit de emergencia (1-3 h).
Materiales: Cuerpo: Aluminio extruido lacado en blanco.
 Reflector: Aluminio facetado brillante.
Acabado: Color blanco RAL 9003 (estándar).
 Disponible gris RAL 9006, negro RAL 9005.



EN

Mounting: Surface.
Light source: LED compact modules COB TRIDONIC.
 Temperature color 4000K. Available, 3000K.
Optical system: Reflector glossy aluminum faceted.
Light distribution: Direct. Standard 24°. Optional 16°, 38°.
Electrical equipment: TRIDONIC Electronic control gear PF>0,95. Available, dimmable 1-10V o DALI and/or emergency kit (1-3 h).
Materials: Body: Aluminum extruded lacquered in white.
 Reflector: Bright anodized aluminum.
Surface finish: White color RAL 9003 (standard).
 Available grey RAL 9006, black RAL 9005.



ESTANDAR | STANDARD
 RXR-130-24°-26W

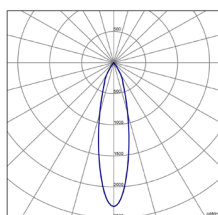

RXR-130-16°-26W

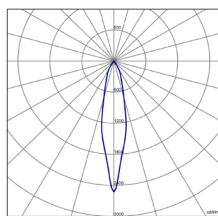

RXR-130-38°-26W

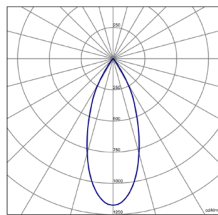

FLICKER FREE



UGR <17

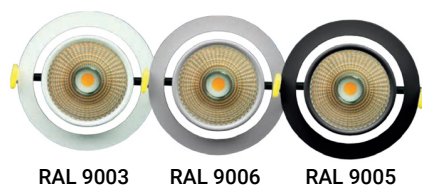

RAL 9003

RAL 9006

RAL 9005

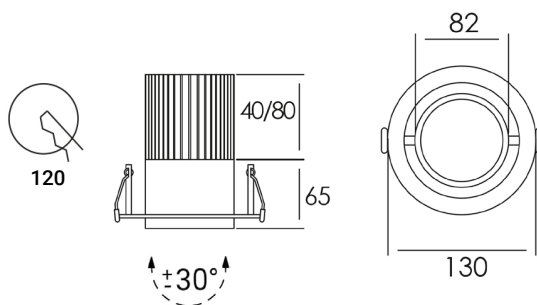

ESTANDAR/STANDARD

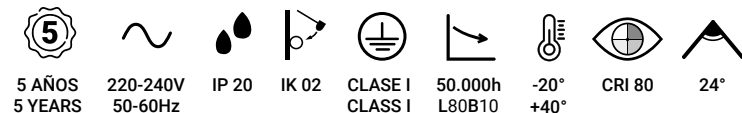

DISPONIBLE/AVAILABLE

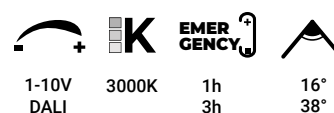

CONFIGURACION ONLINE ONLINE CONFIGURATION



Código Code	Referencia Reference	Kg	Potencia Power	Lúmenes Lumens	Eficiencia Efficiency	CCT (K)
RXR102K0B	RXR-130-24°-13W 2000lm/840	0,5	13W	2000	154 lm/W	4000
RXR103K0B	RXR-130-24°-19W 3000lm/840	0,5	19W	3000	158 lm/W	4000
RXR104K3B	RXR-130-24°-26W 4300lm/840	0,7	26W	4300	165 lm/W	4000

ACCESORIOS DISPONIBLES/AVAILABLE ACCESSORIES

REGULACION/DIMMING 1-10V | DALI KIT DE EMERGENCIA/EMERGENCY KIT 1h | 3h T.COLOR 3000K OPTICA/LENS 16°, 38°